

NIXON

Sofa range

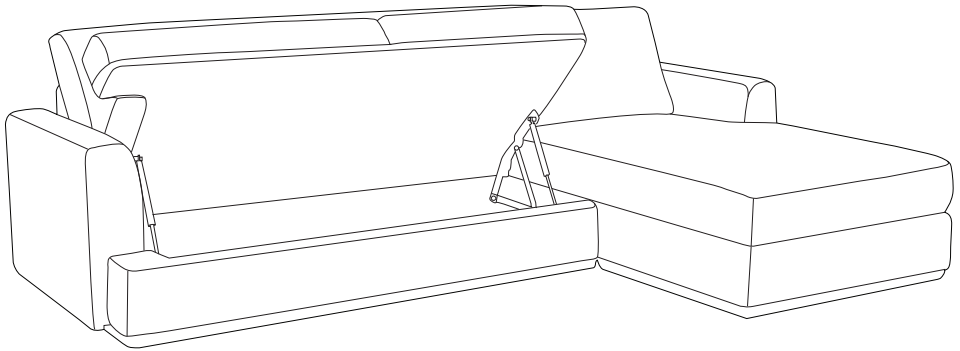

THE STORY

The Nixon range is the epitome of function and style. Angled arms cater to your comfort while foam and fibre cushions add that extra support just where you need it. We love the hidden storage option which makes it ideal for apartment living, families and busy lifestyles. Textured fabric and a timber plinth detail gives the Nixon sofa modern sophistication with a nod to mid century style.

MATERIALS

This Sofa uses timber as a frame comprising timber composites. It's cushion fill is made of foam and fibre composites. It has webbing and spring seat suspension for long term support and consistent comfort; and webbing suspension in the back.

FABRIC & COLOURS

Amaro: Thunder and Rainstorm
82% Polyester, 18% Acrylic

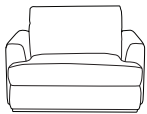

Armchair
w 118 d 94 h 85

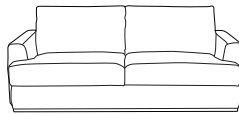

2 seat sofa (includes storage)
w 160 d 94 h 85

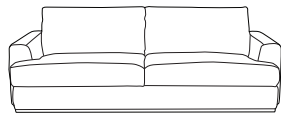

3 seat sofa (includes storage)
w 200 d 94 h 85

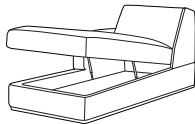

Chaise LAF
w 94 d 165 h 85

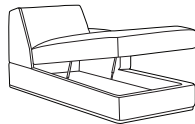

Chaise RAF
w 94 d 165 h 85



3 seat LAF modular
w 169 d 94 h 85

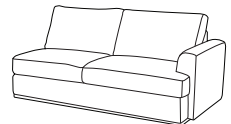

3 seat RAF modular
w 169 d 94 h 85

*Note: measurements are in centimetres and are approximate only.

Explanation: LAF and RAF: Left Arm Facing and Right Arm Facing; as you stand in front of the sofa the arm will be on either the left or right side of the modular component. Please refer to website for care instructions: www.freedom.com.au While we aim to ensure that the information on this tearsheet is correct at the time of printing, it is sometimes necessary for changes to be made to product specifications. To avoid disappointment, we suggest that you obtain confirmation of product specifications and availability with your freedom salesperson before placing your order.